

2

3

1

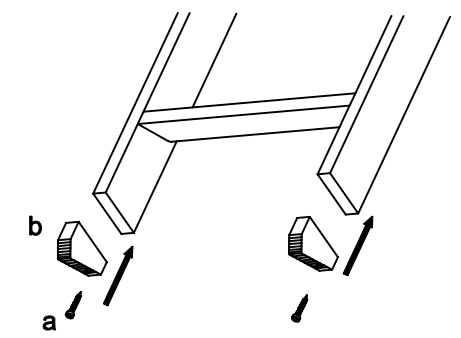
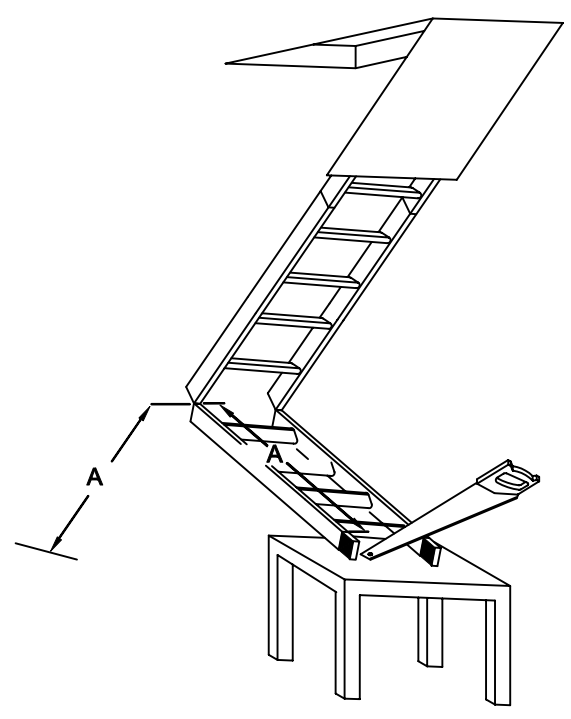
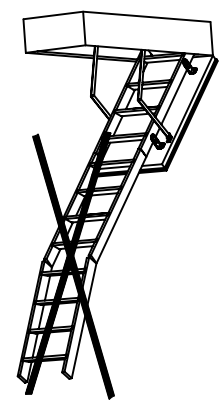

4

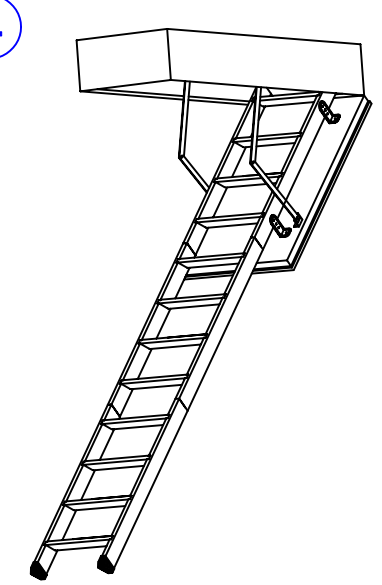

R1 99449 / 290713

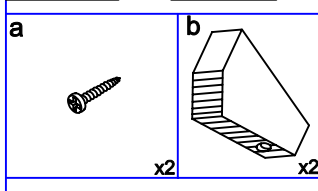

2

3

1

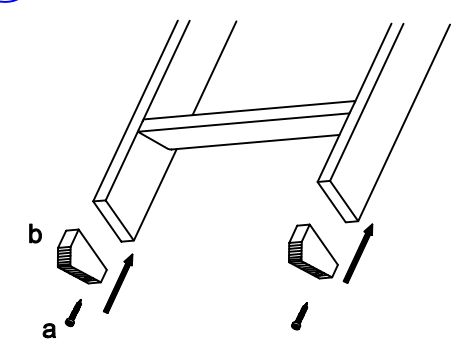
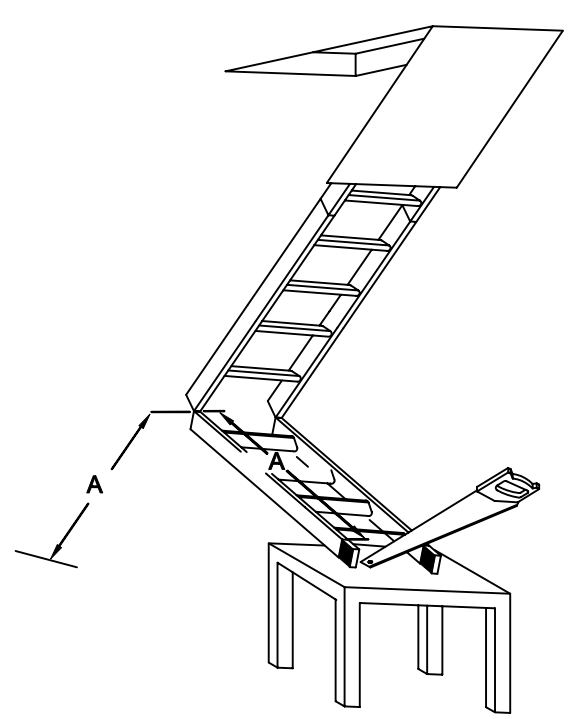
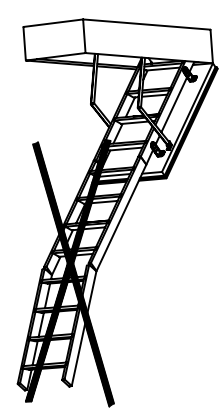

4

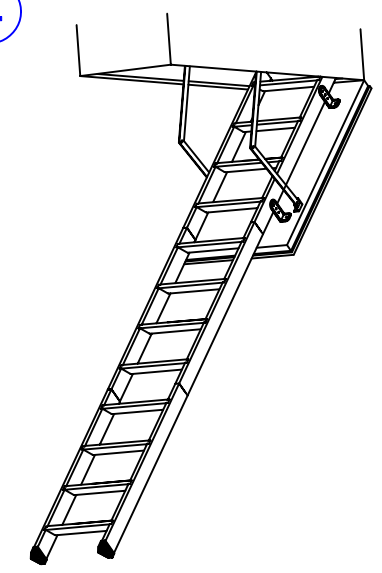

R1 99449 / 290713